

# DISC SURFACE Installation Manual

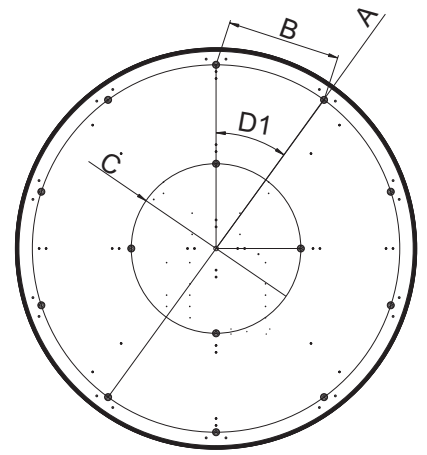
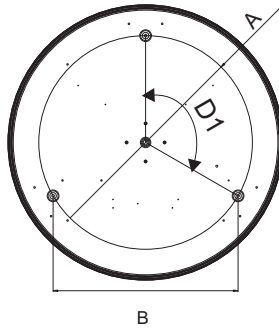
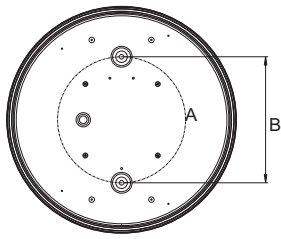

#	A	B
Ø270	150	150

#	A	B	D1
Ø400	250	216,5	120°
Ø580	400	390	120°

#	A	B	C	D1
Ø850	730	429	200	72°
Ø1130	1010	438	500	51,4°
Ø1420	1300	402	600	36°

Drill accordingly to the tables above.

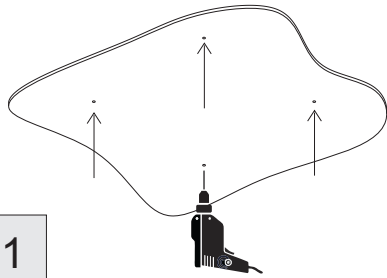

Mount to the ceiling using appropriate anchor

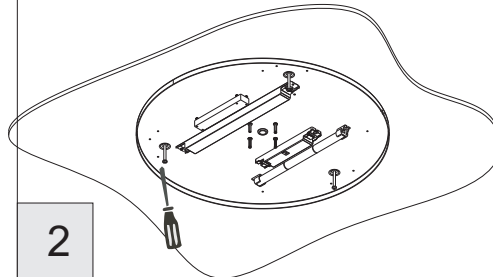

The luminaire must be connected only by a qualified electrician.

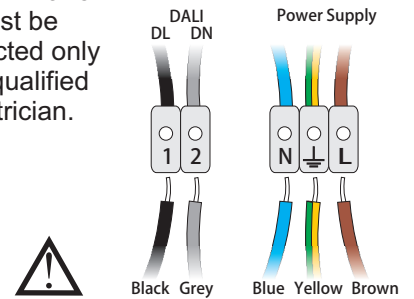

Mount the LED modules in place following the instructive stickers.

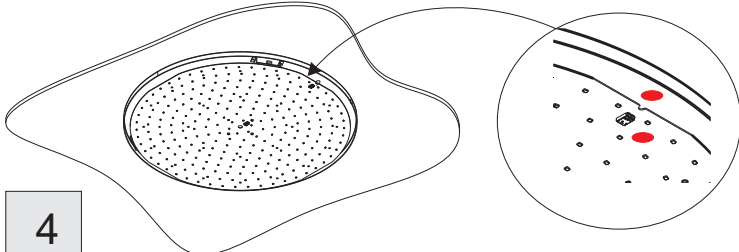

Connect the Led modules to the Driver as shown below.

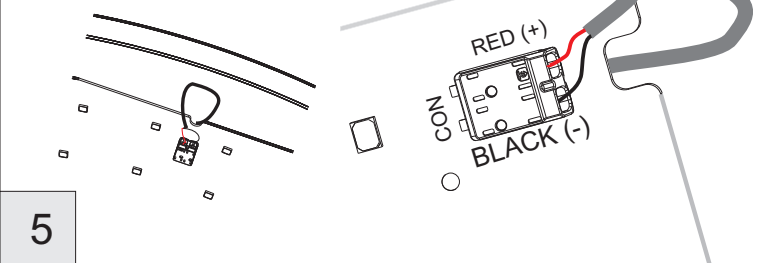

Secure the springs in place using the provided accessory.

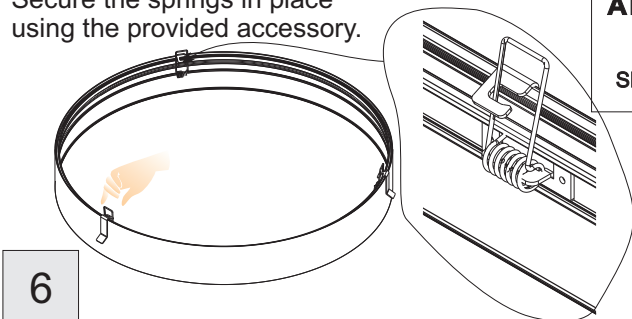

**ATTENTION: HANDLE CAREFULLY THE LUMINAIRE'S BASE WHEN THE SPRINGS ARE SECURED IN THE UPPER POSITION.**

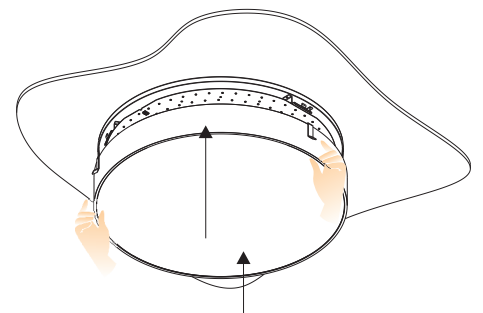

Hook all the springs in to the appropriate points as shown below:

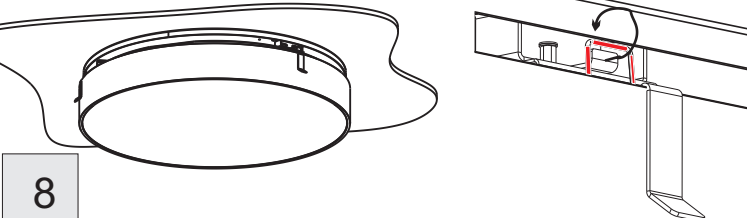

**Carefully** remove the provided accessory from each spring.

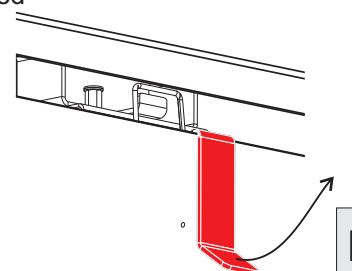

# DISC SURFACE Installation Manual

In order to remove the Luminaire's base the following steps must be followed.

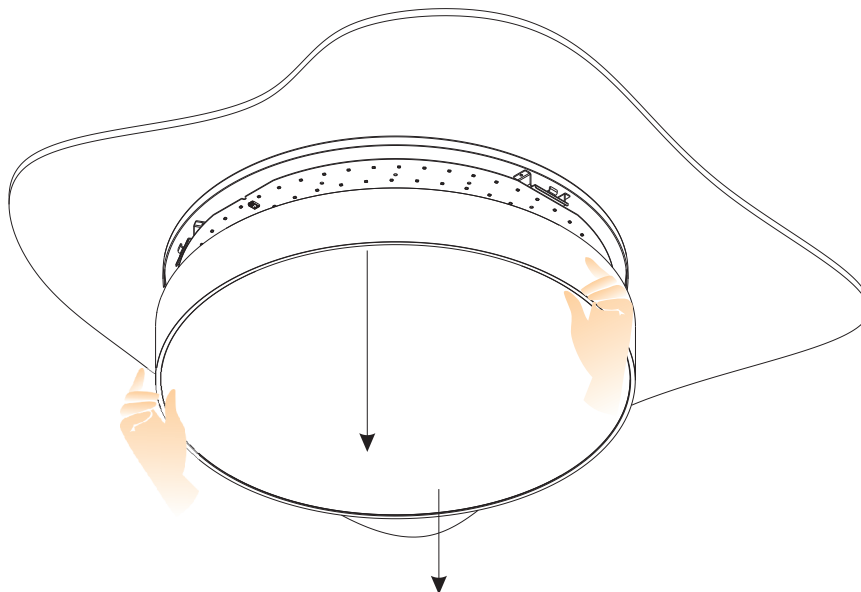

1

Pull down the luminaire's base in order to expose the mounting springs.

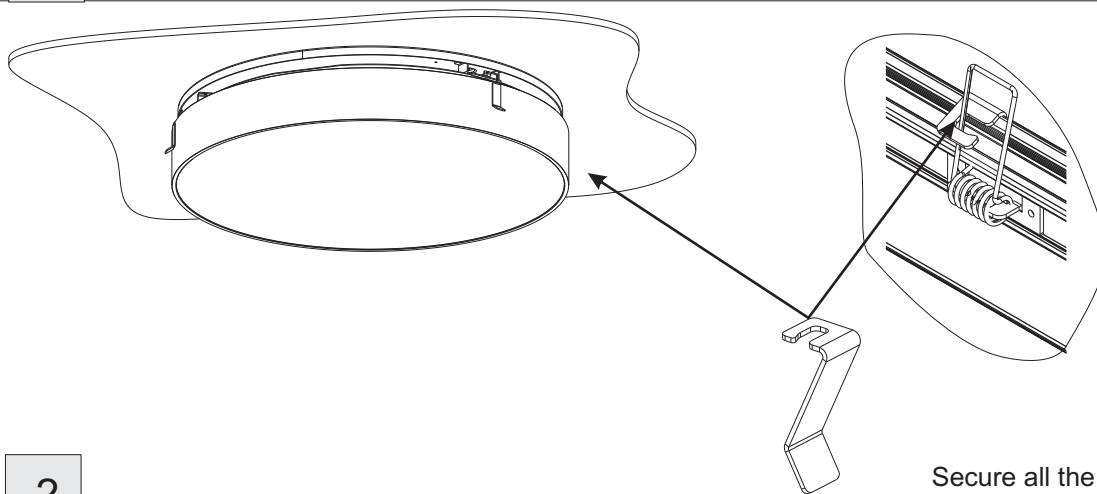

**ATTENTION: HANDLE CAREFULLY THE LUMINAIRE'S BASE WHEN THE SPRINGS ARE SECURED IN THE UPPER POSITION.**

2

Secure all the springs in the upper position using the provided accessory.

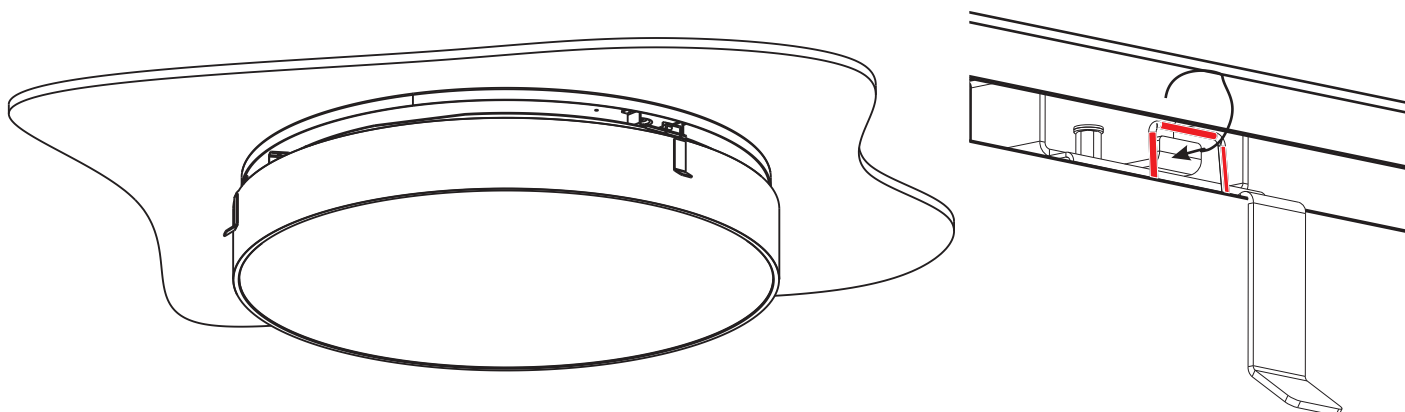

3

Unhook all the springs from the mounting points as shown above.

P.2